

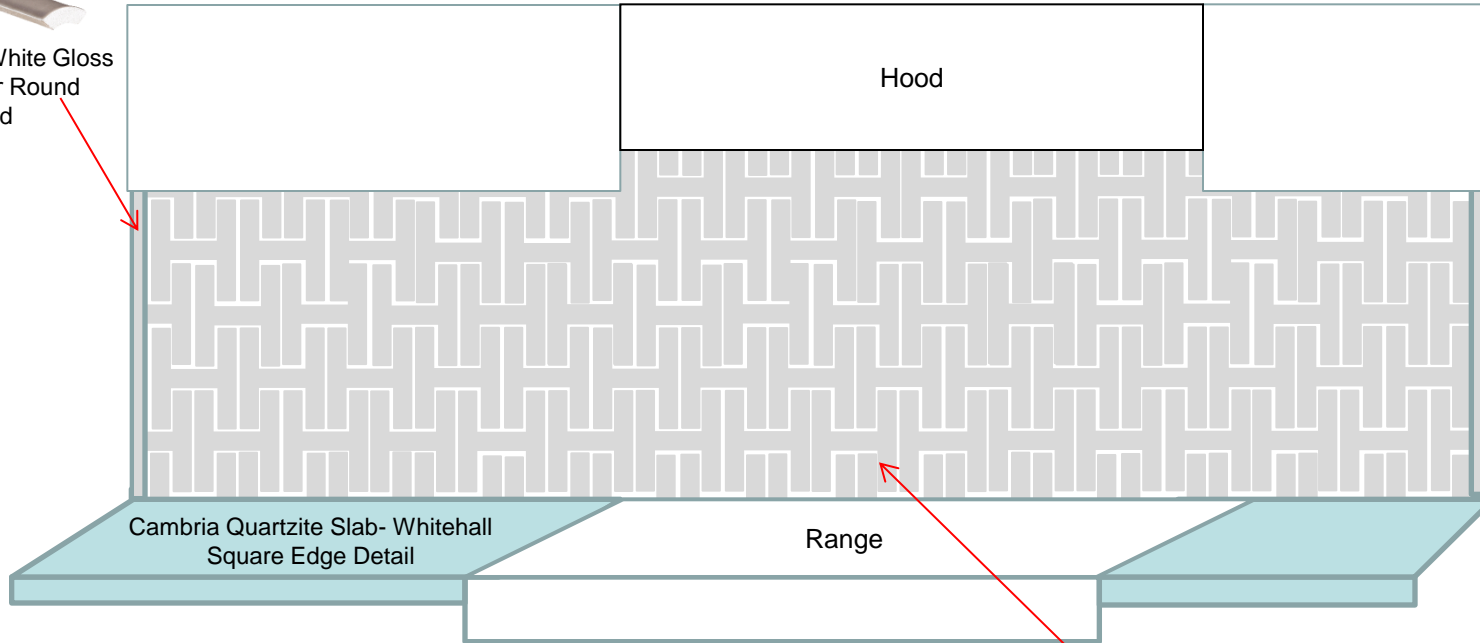

Fireclay White Gloss
6" Quarter Round
As Needed

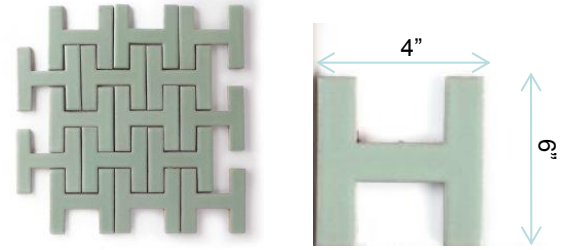

FILL TO
UPPER CABS - APPROX 18"

KITCHEN ISLAND:

Cambria Quartzite Slab- Torquay
**4" Apron Knife Edge Detail at Kitchen Island
Please prep cabinets

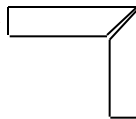

4" KNIFE EDGE
FACE OF COUNTER

Full Splash
Fireclay Chaine Homme Pattern
White Gloss Finish

Backsplash Grout:
Custom #386 Oyster Gray

PAINT: Kelly-Moore Rotunda White KM5819
UPPER CABINETS (Includes Towers): SW7757 High Reflective White (Sherwin Williams)
LOWER CABINETS (Includes Island): SW7076 Cyberspace (Sherwin Williams)

Trim:
Intertile
KEN MASON
Basix 5" Quarter Round
Color: Glossy White

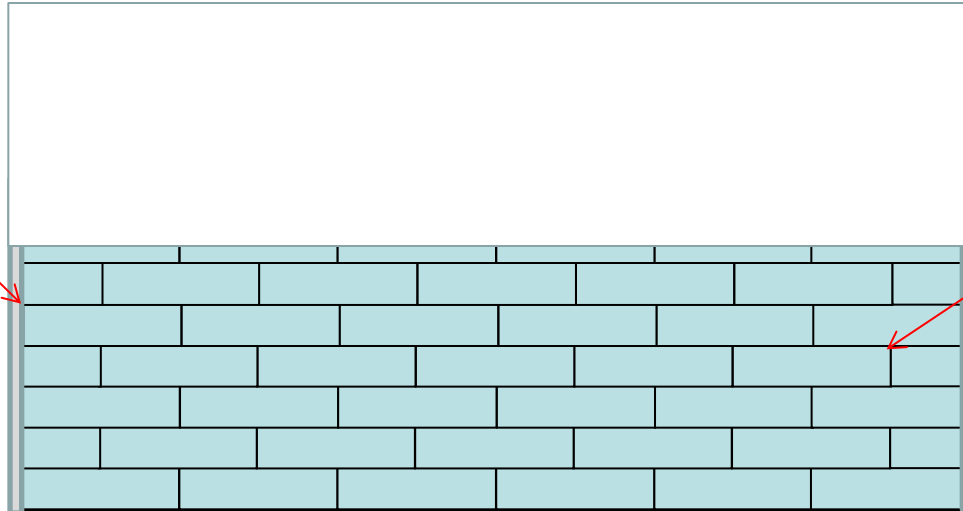

Full Splash:
Intertile
KEN MASON
Basix 2x13" Brick Installation
Color: White



Cambria Quartzite Slab- Torquay
Square Edge Detail

Backsplash Grout:
Custom #386 Oyster Gray

PAINT: Kelly-Moore City Dweller KM4941
UPPER CABINETS: SW7757 High Reflective White (Sherwin Williams)
LOWER CABINETS: SW7076 Cyberspace (Sherwin Williams)

LIVORNA - PARCEL B

Laundry Counter & Flooring Tile Diagram

Trim:
Intertile
KEN MASON
Basix 5" Quarter Round
Color: Glossy White

FILL TO
UPPER CABS-
APPROX 18"

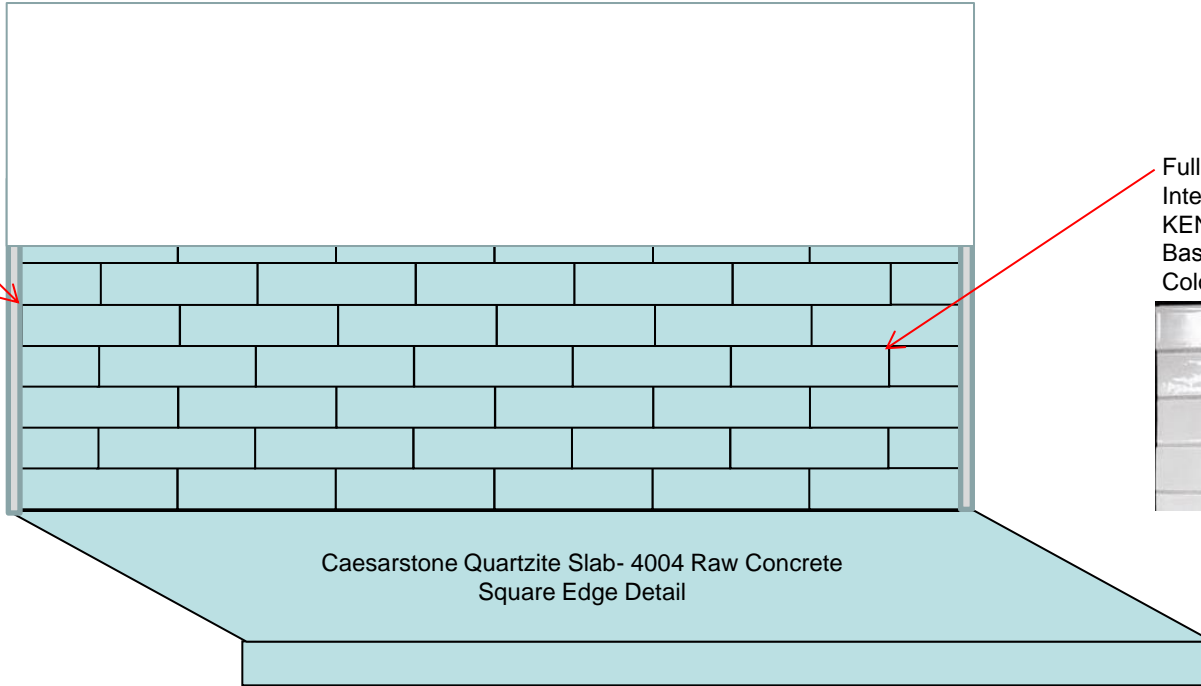

Full Splash:
Intertile
KEN MASON
Basix 2x13" Brick Installation
Color: White



Caesarstone Quartzite Slab- 4004 Raw Concrete
Square Edge Detail

Backsplash Grout:
Custom #386 Oyster Gray

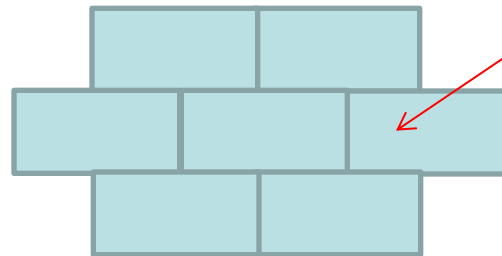

Intertile-
Gascogne Blue Honed Limestone
12x24"
Split-Joint Installation



Flooring Grout: Custom #386 Oyster Gray

PAINT: Kelly-Moore Rotunda White KM5819
CABINETS: SW7757 High Reflective White (Sherwin Williams)



Single Row:
Dal Tile Color Wave, Feather White
Straight-Joint Mosaic CW02 1x6"



Arizona Tile
White Glossy
1x6" Bead Trim

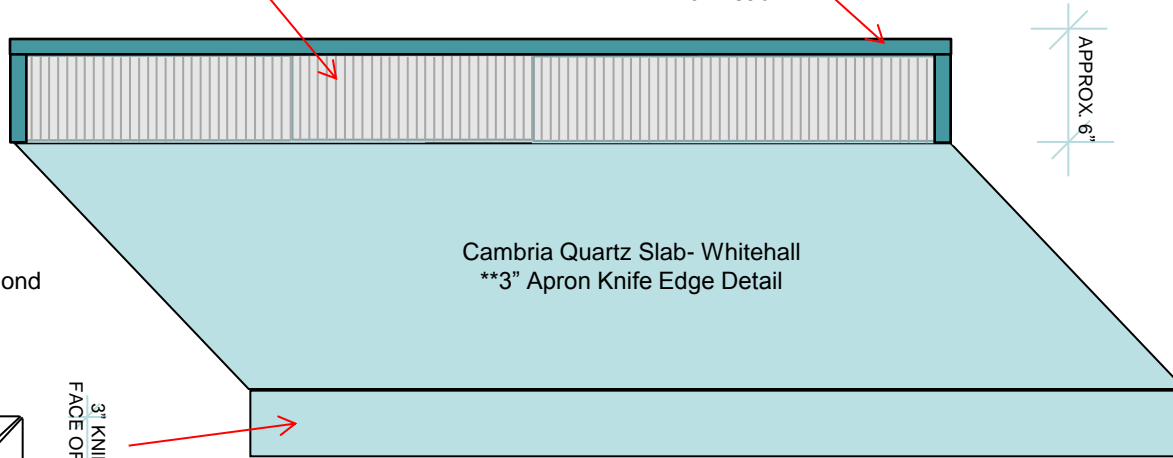

Backsplash Grout:
Bostik, Dimension #H600 Diamond

Cambria Quartz Slab- Whitehall
**3" Apron Knife Edge Detail

APPROX. 6"

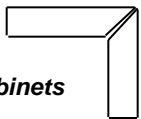

3" KNIFE EDGE
FACE OF COUNTER

**Please prep cabinets*

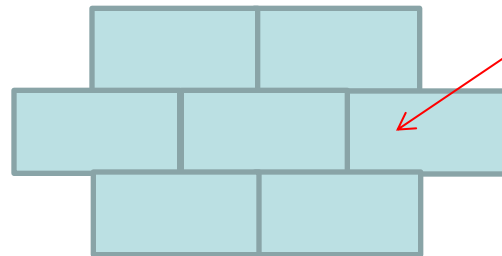

Intertile-
Gascogne Blue Honed Limestone
12x24"
Split-Joint Installation



Flooring Grout: Custom #386 Oyster Gray

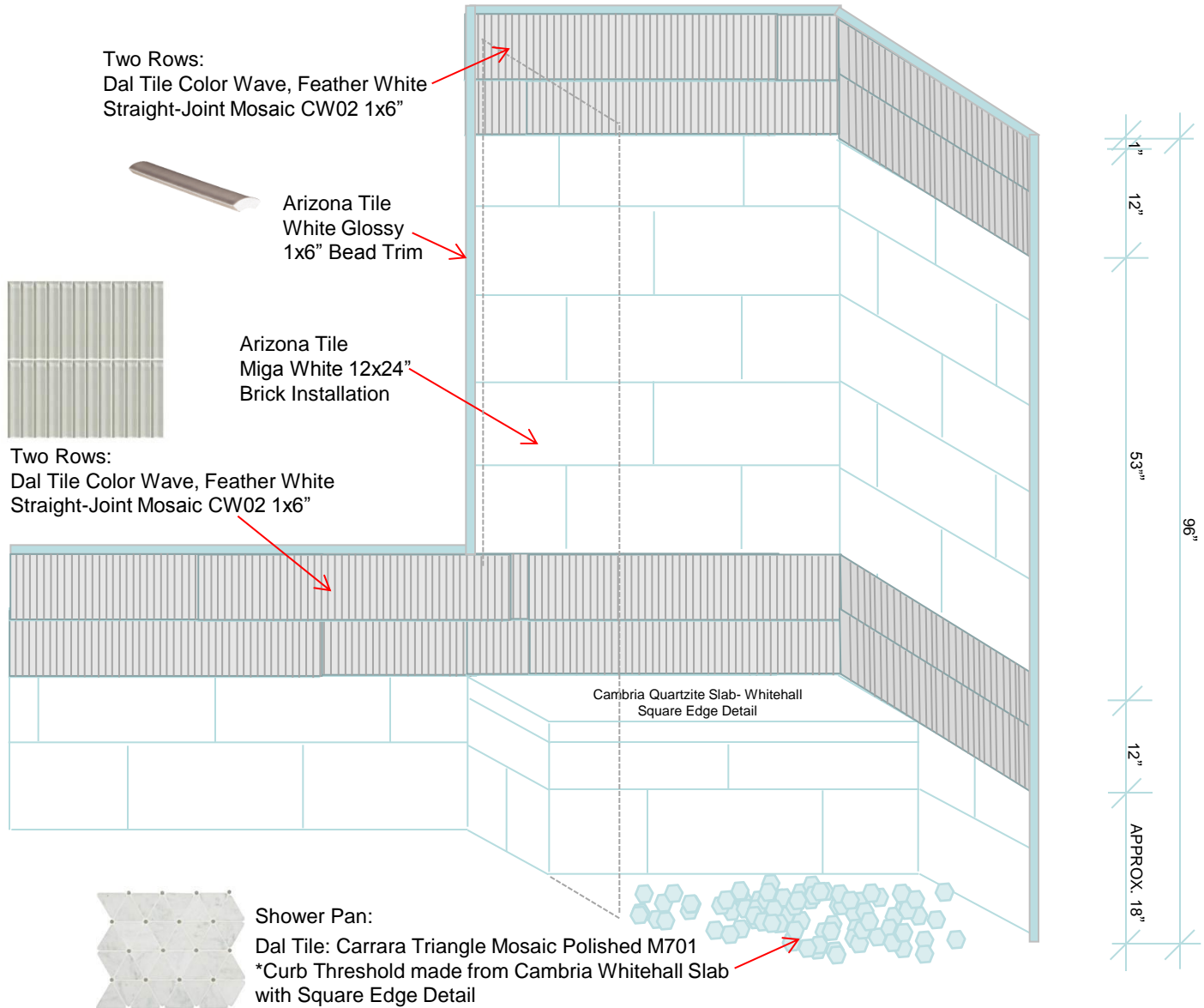

PAINT: Kelly-Moore City Dweller KM4941

CABINETS: SW7076 Cyberspace (Sherwin Williams)

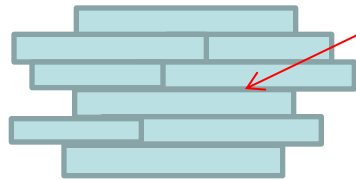
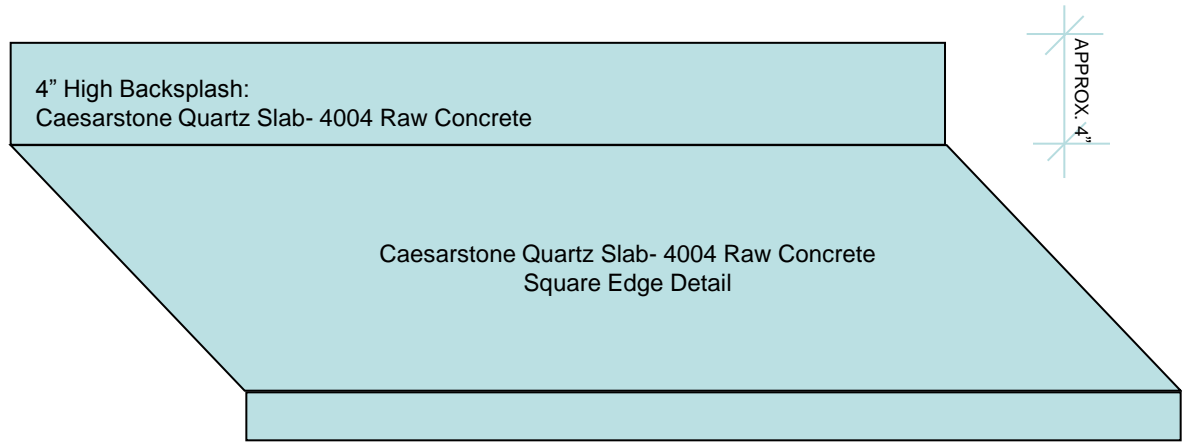

Arizona Tile
Club Tobacco
6x24"
Split-Joint Installation



Flooring Grout: Custom #183 Chateau

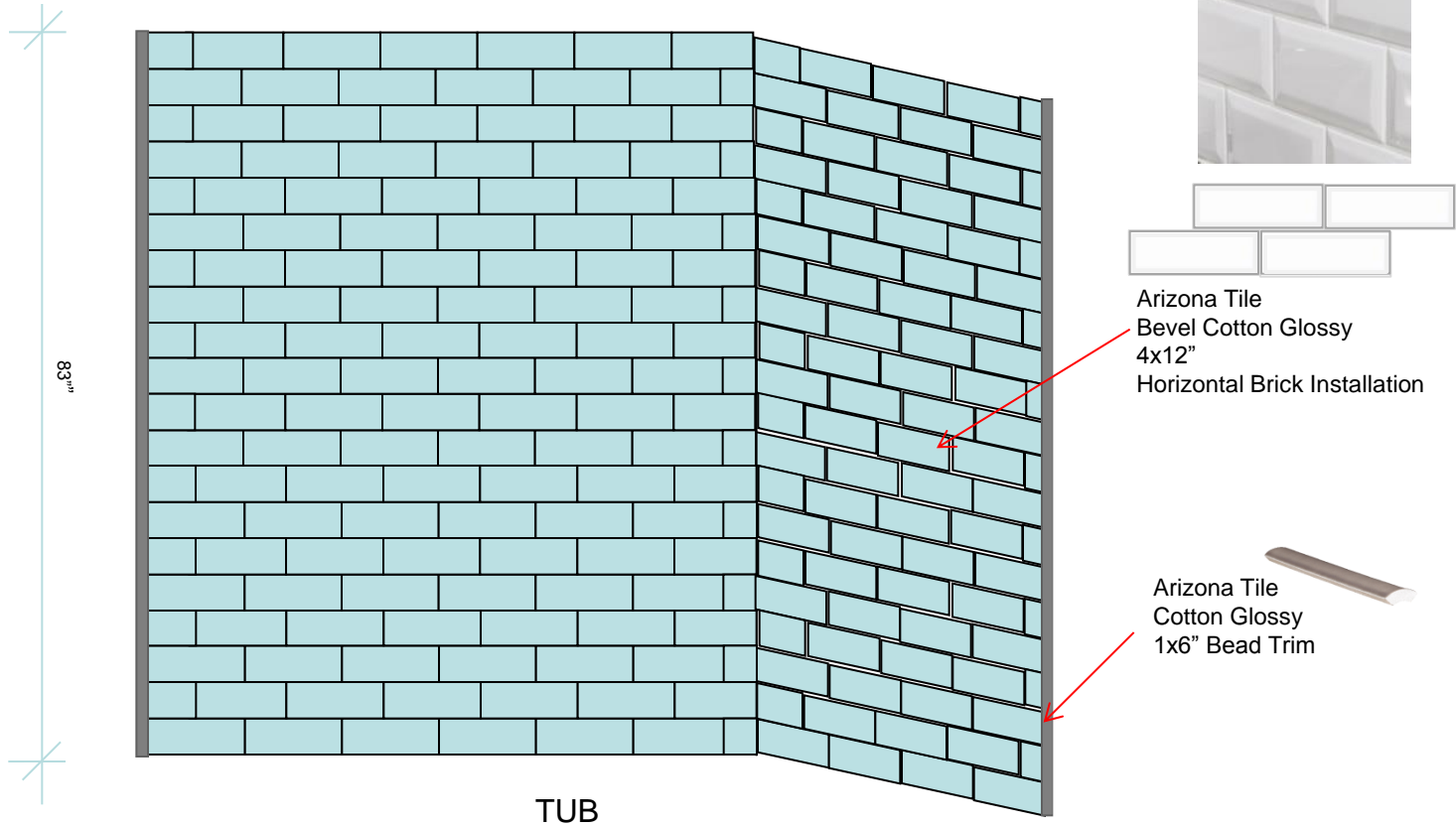

Grout:
Custom #386 Oyster Gray

PAINT: Kelly-Moore City Dweller KM4941
CABINETS: SW7757 High Reflective White (Sherwin Williams)

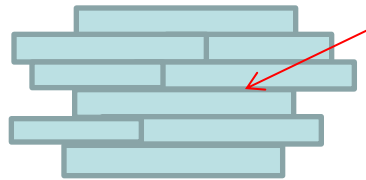
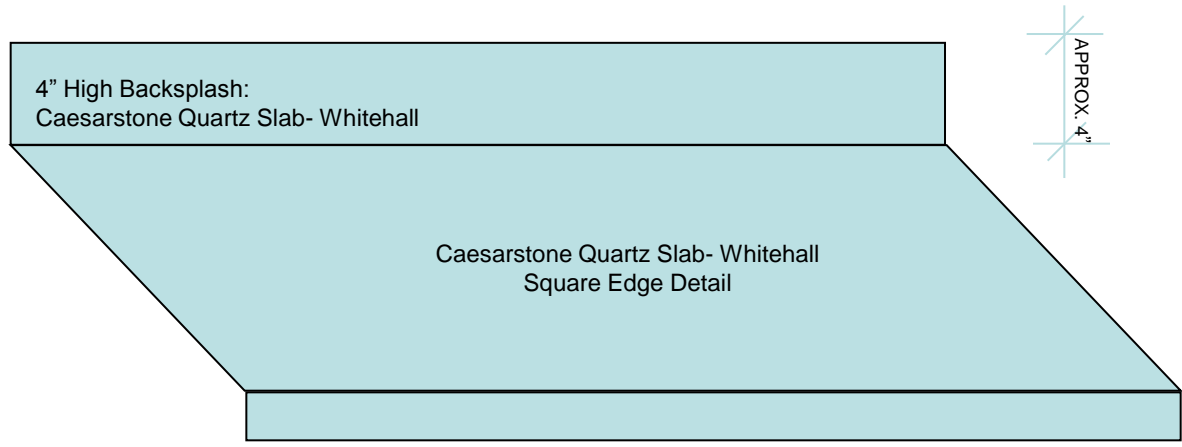

Arizona Tile
Club Tobacco
6x24"
Split-Joint Installation



Flooring Grout: Custom #183 Chateau

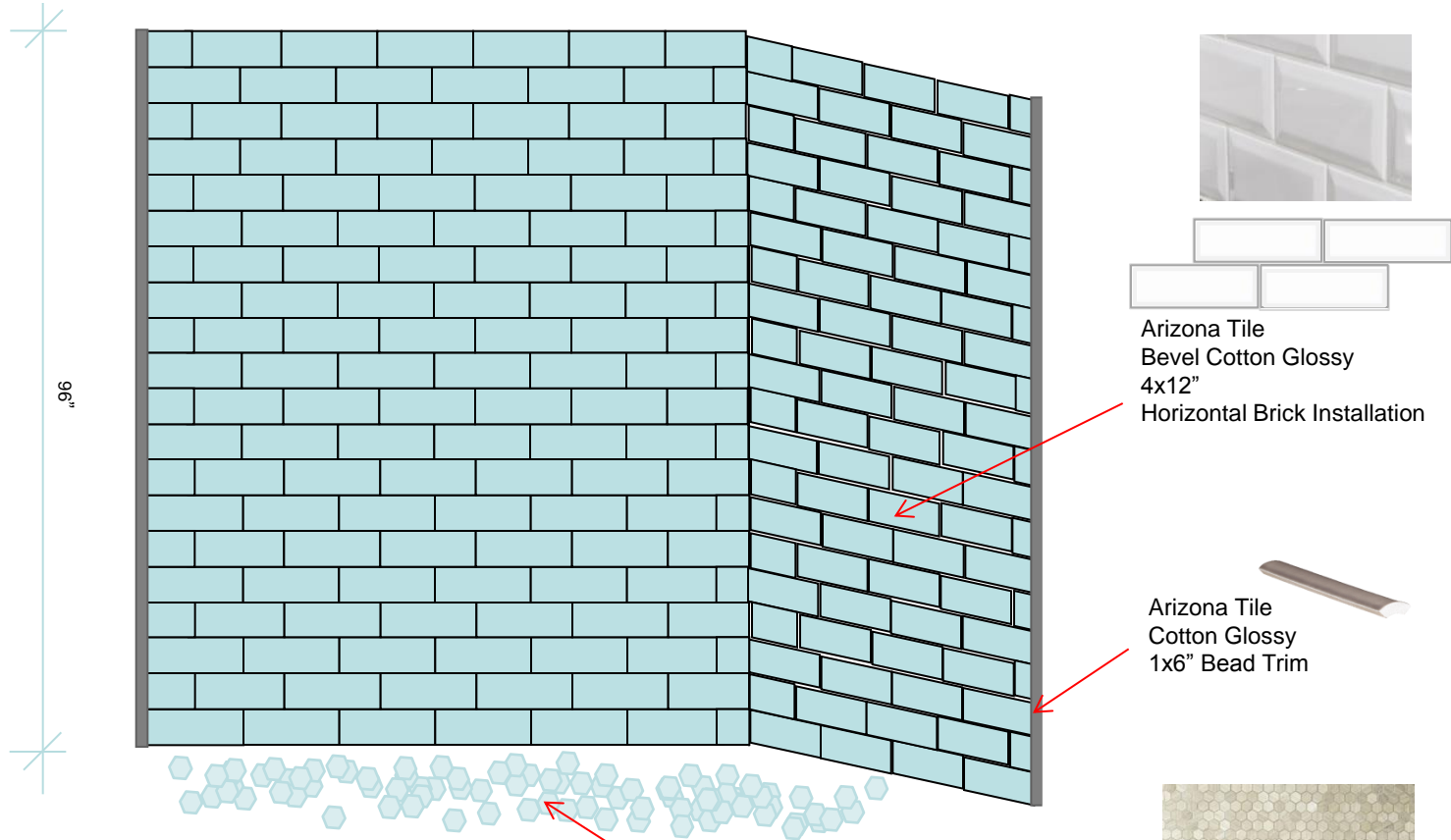

Arizona Tile
Bevel Cotton Glossy
4x12"
Horizontal Brick Installation

Arizona Tile
Cotton Glossy
1x6" Bead Trim

Shower Pan:
Arizona Hampton Silver 1" Hexagon Mosaic
*Curb Threshold made Cambria Whitehall Slab
with Square Edge Detail

Grout:
Custom #386 Oyster Gray

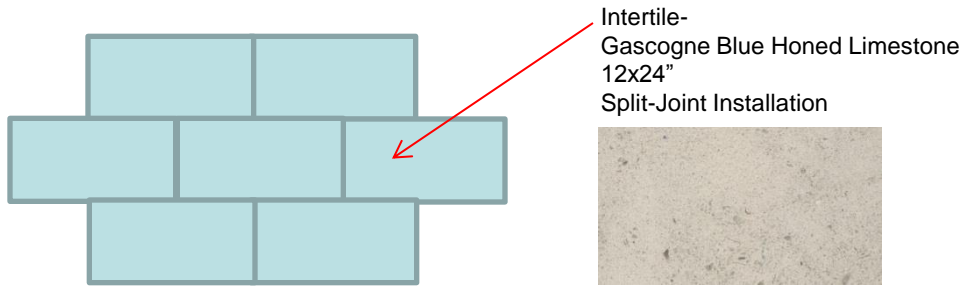
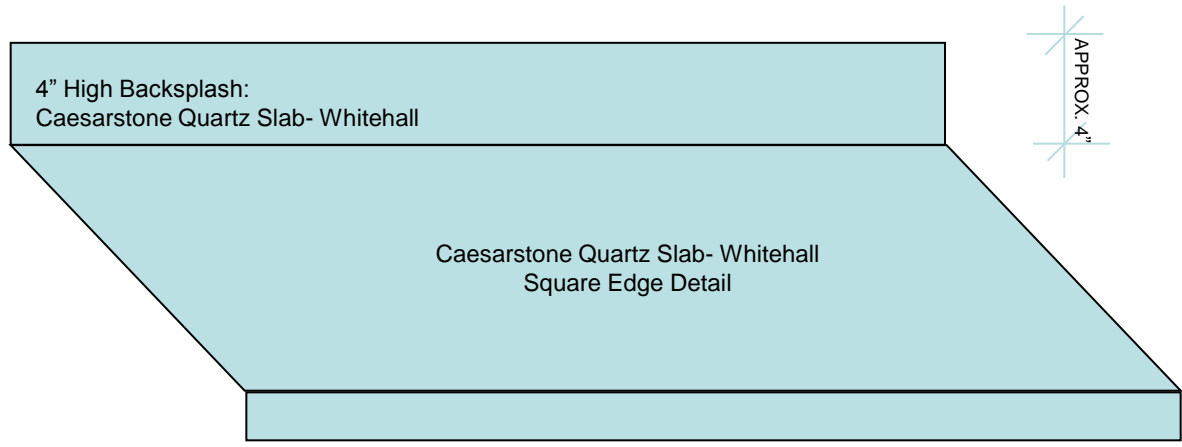

Flooring Grout: Custom #386 Oyster Gray

PAINT: Kelly-Moore Big Band KM5828-2
CABINETS: SW7076 Cyberspace (Sherwin Williams)

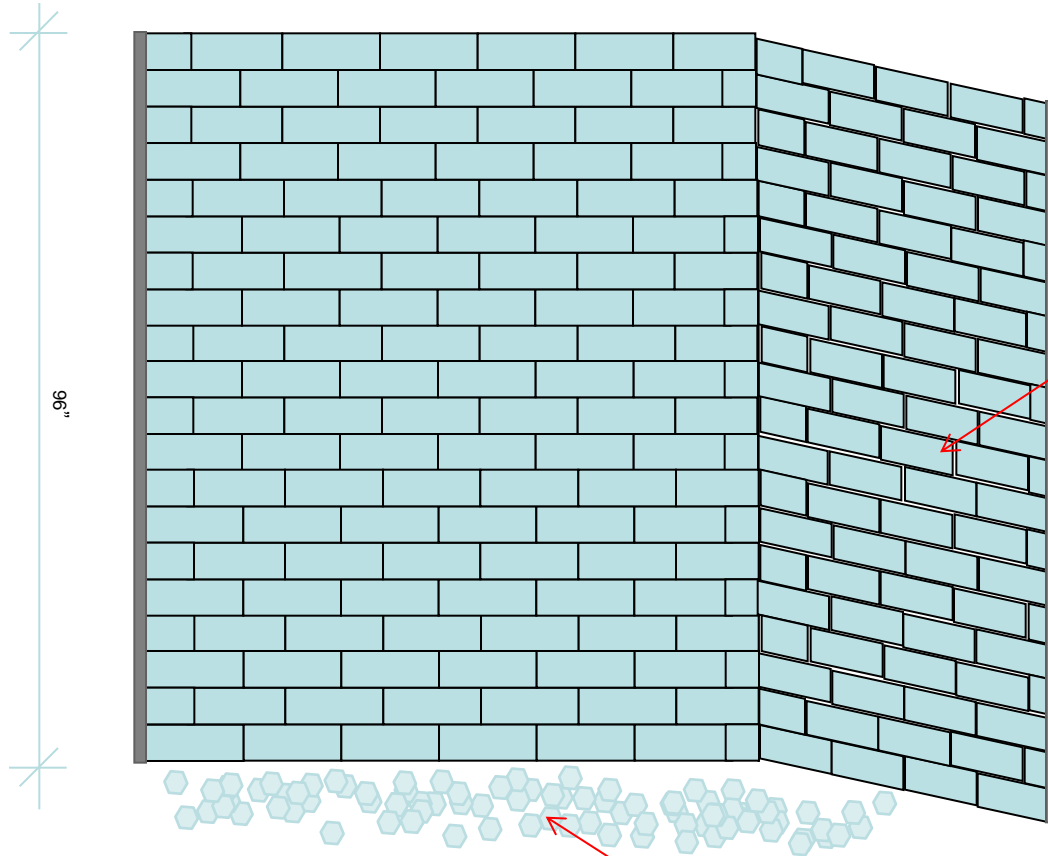

96"



Intertile
KEN MASON
Basix 2x13" Brick Installation
Color: White

Trim:
Intertile
KEN MASON
Basix 5" Quarter Round
Color: Glossy White



Grout:
Custom #386 Oyster Gray

Shower Pan:
Arizona Hampton Silver 1" Hexagon Mosaic
*Curb Threshold made Cambria Whitehall Slab
with Square Edge Detail

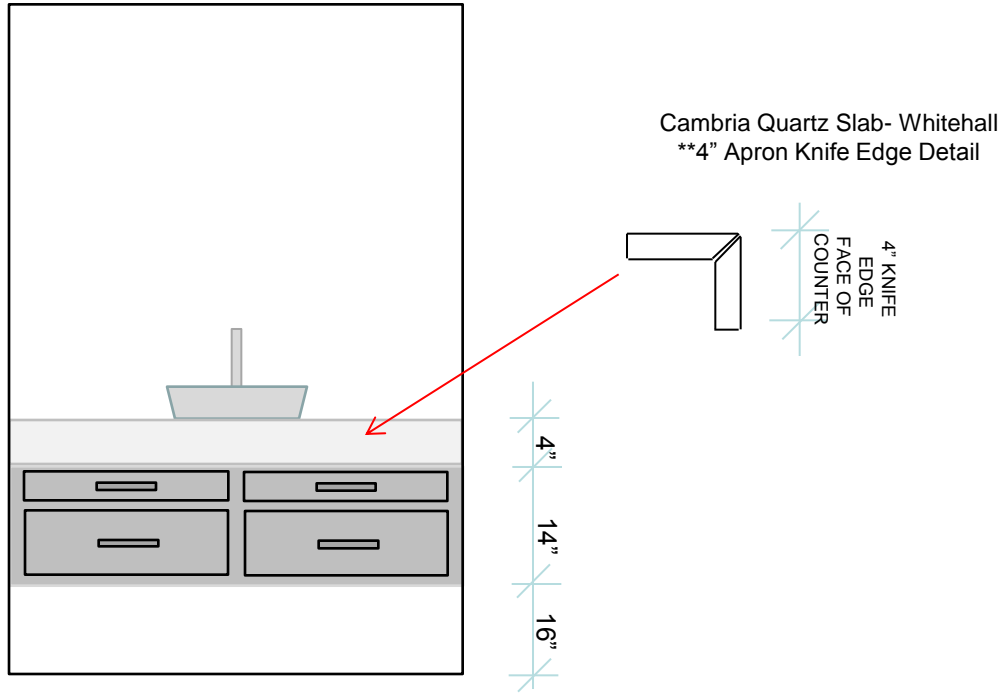

LIVORNA - PARCEL B



El Dorado Stone
The 'Giada'
Aged Teak, Honed Finish

Living Rm Fireplace Diagram

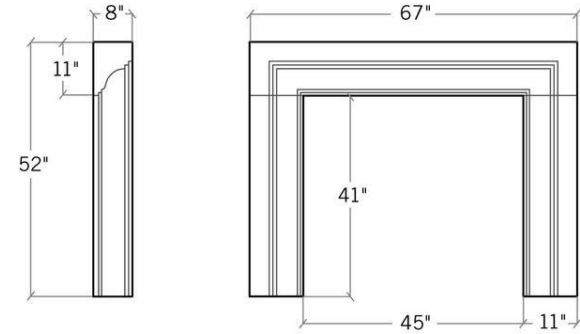

Family Rm Fireplace Diagram

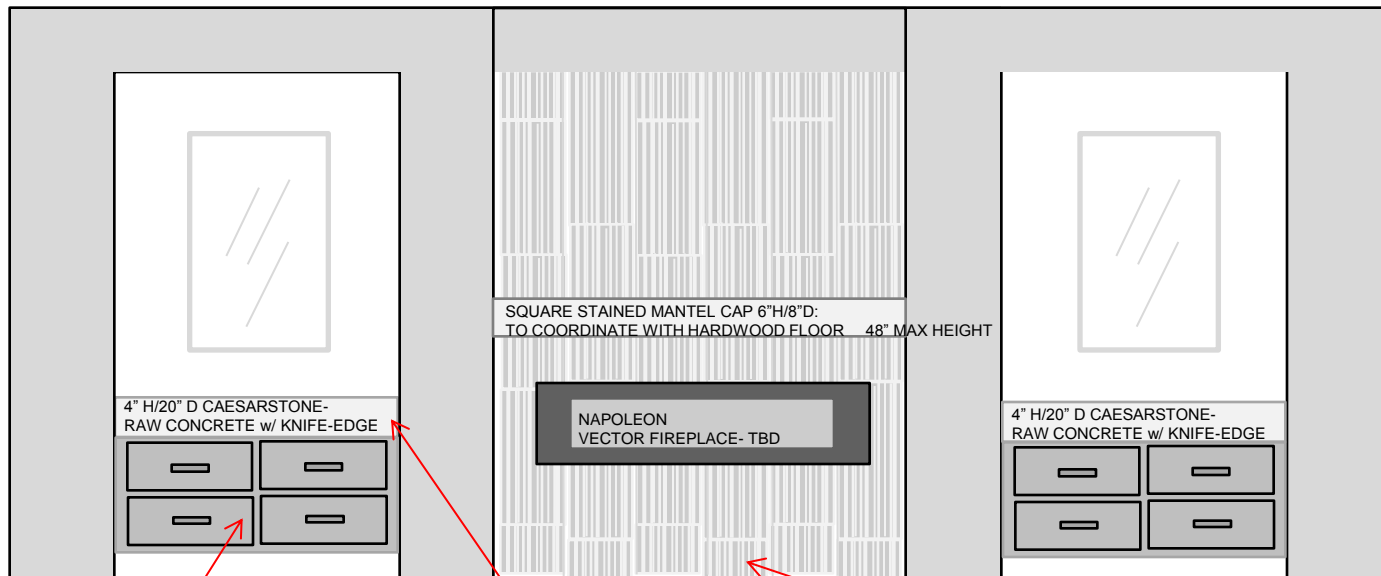

Cabinet:
Sherwin Williams SW7076 Cyberspace
Satin Finish (No Glaze)

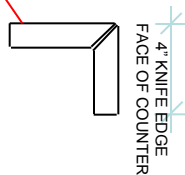

Intertile
Gascogne Blue Honed Limestone
12x24" Vertical Split-Joint Installation
Grout: Custom #386 Oyster Gray